











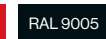

Standard Unit Dimensions:

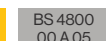
Width: 1450mm
Height: 800mm

Colours/Finishes:

 Galvanised Only	 RAL 9006 White Aluminium	 RAL 7016 Anthracite Grey
 BS 4800 10 A 07 Nimbus Grey	 RAL 3020 Traffic Red	 RAL 9005 Jet Black
 BS 4800 14 C 39 Holly Green	 RAL 1023 Traffic Yellow	 BS 4800 00 A 05 Goose Grey
 RAL 5015 Mid Blue	 RAL 5013 Dark Blue	 RAL 9016 Traffic White

The colours shown are a guide only.
Please check a colour chart to see the
actual colour.

Product Information

The Oakdale Cycle Stand is a space saving wall mounted tubular cycle support.

Features

- Space saving wall mounted tubular cycle support
- Preferred by regular users as whole cycle is secured
- Available in 50mm dia.
- Hot dip galvanised to BS EN ISO 1461:2009

Materials Used

- Framework - Mild Steel

Finish Options

- Galvanised to BS EN ISO 1461:2009
- Galvanised to BS EN ISO 1461:2009 & Polyester Powder Coated
- Stainless Steel Grade 304
- Stainless Steel Grade 316

Broxap Limited, Rowhurst Industrial Estate, Chesterton, Newcastle-under-Lyme, Staffordshire, ST5 6BD T: 01782 564411 E: info@broxap.com W: www.broxap.com



ISO 9001
Quality
Management
Systems
CERTIFIED

ISO 14001
Environmental
Management
CERTIFIED

ISO 45001
Occupational
Health and Safety
Management
CERTIFIED



Oakdale Cycle Stand BXMW/OAK

Guarantees, Warranties, Design-Life and Life-Expectancies

- 34 year (min) life expectancy for Hot Dip Galvanizing
- 8-10 year life expectancy on standard powder coatings
- 10-15 year life expectancy on Duplex (Zinc Coated) powder coatings
- 12 months' warranty* on parts & labour

*Maintenance and other qualifying criteria apply

Options

- Stainless steel with pre-drilled wall and base plates
- Submerged fixing option available
- Junior size available at 600mm high



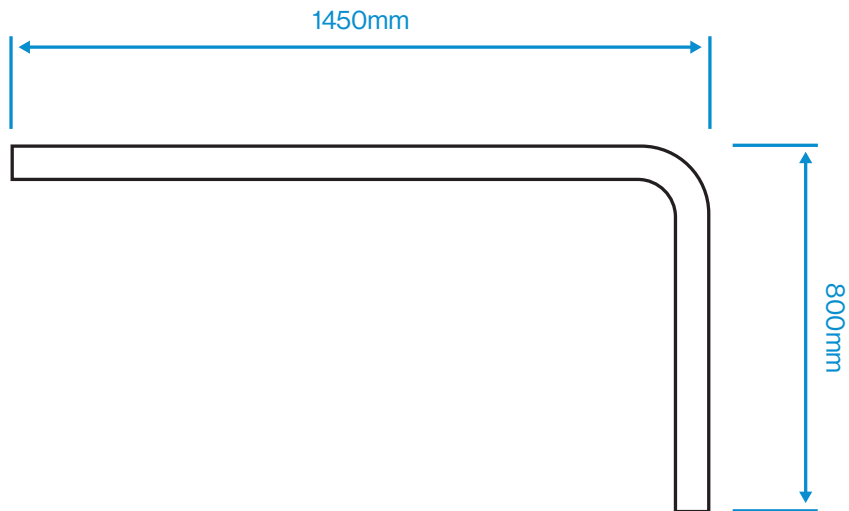





Diagram

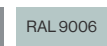
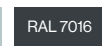

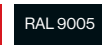
Standard Unit Dimensions:

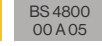
Width: 1450mm
Height: 800mm

Colours/Finishes:

 Galvanised Only	 RAL 9006 White Aluminium	 RAL 7016 Anthracite Grey
 BS 4800 10 A 07 Nimbus Grey	 RAL 3020 Traffic Red	 RAL 9005 Jet Black
 BS 4800 14 C 39 Holly Green	 RAL 1023 Traffic Yellow	 BS 4800 00 A 05 Goose Grey
 RAL 5015 Mid Blue	 RAL 5013 Dark Blue	 RAL 9016 Traffic White

The colours shown are a guide only.
Please check a colour chart to see the
actual colour.

Broxap Limited, Rowhurst Industrial Estate, Chesterton, Newcastle-under-Lyme, Staffordshire, ST5 6BD T: 01782 564411 E: info@broxap.com W: www.broxap.com

